

VisSim/Embedded Controls Developer For F28069

Quick Start Guide

This quick start guide gets you started using VisSim/Embedded Controls Developer (VisSim/ECD) by providing the following information:

- VisSim/ECD overview
- Installing VisSim/ECD
- Navigating the VisSim window
- Building a simple model
- Exploring the sample diagrams and online movies

What is VisSim/ECD

VisSim/ECD is a visual block diagram environment for model-based development of embedded systems for Texas Instruments microcontrollers.

Using VisSim/ECD, you can easily create a working model of your control and the system you are controlling. This model can be simulated, debugged in simulation, compiled and then downloaded to the target using the JTAG hotlink. VisSim/ECD generates production-quality code that has performance in speed and space usage within 5% of expert hand code. VisSim also provides interactive sliders, buttons, gauges, and plots for fast high-level debugging.

VisSim also provides a UML State Chart modeler with built-in C interpreter allowing for simulation and code generation of state charts for sequential state operations. VisSim blocks perform operations as simple as a gain, or as complex as numerical integration, transfer function or FFT. To support TI processors like Piccolo, VisSim has target specific blocks for all on-chip peripherals, including PWM, ADC, Comparators, I2C, SPI, SCI, QEP, CAP, CAN, watchdog and interrupts. VisSim supports simulation and code generation for both fixed and floating point targets.

What you get with VisSim/ECD 60-day trial software

- Professional VisSim with full simulation capability
- VisSim/Fixed-Point block set
- Automatic C code generator for the TI C2000
- VisSim TI Piccolo peripheral block set
- TI digital motor control (DMC) block set
- VisSim/UML State Charts
- Interactive JTAG HotLink for download and debugging
- High fidelity electric motor simulation block set for AC, DC, BLDC and PMSM motors.
- Extensive examples in many engineering domains

Installing VisSim/ECD

It is important to note that the target hardware is not required for model development; however, a compiler (like the TI C2000 Code Composer) is required for compiling code.

In addition, your computer must meet the following minimum configuration in order to install VisSim/Embedded Controls Developer and develop for the F28069 target:

- Windows XP, Vista, or 7
- TI C2000 Code Composer Studio v4.2.1+
- 110 MB free hard disk space
- USB for JTAG interface

To install VisSim/ECD

Install the TI C2000 Code Composer Studio v4.2.1+.

Click on the following URL or copy and paste it into your browser:

<http://www.vissim.com/piccolo>

After entering your download request you will receive an email with the URL to the VisSim/ECD install with further instructions

Run the the install and follow the on-screen installation instructions.

Exploring the VisSim window

When you start VisSim for the first time – by clicking on the **VisSim** icon on your desktop or clicking on the **Start > All Programs > VisSim 8.0 – Software** – a VisSim window is opened containing an empty block diagram named *Diagram1*.

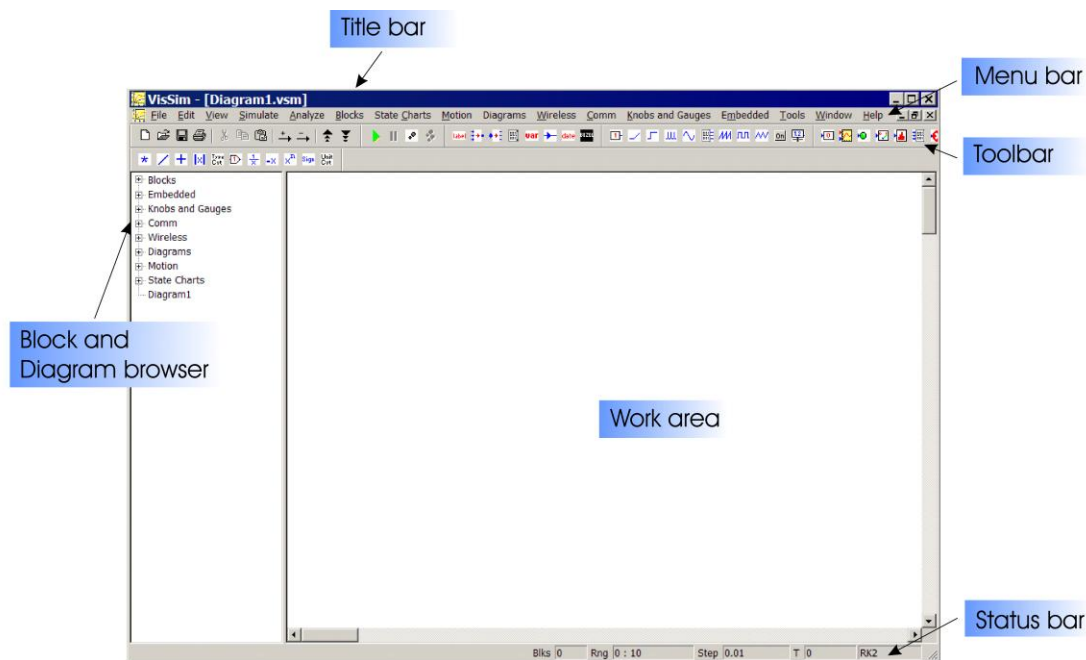

Element	Purpose
Title bar	Displays the name of the currently active VisSim diagram and your location within the diagram.
Menu bar	Lists all VisSim commands and blocks. The Embedded menu item contains target-specific and Digital Motor Control blocks.
Toolbar	These buttons represent commonly used VisSim commands and blocks.
Work area	This is largest part of the VisSim window and it is where you build your models in the form of block diagrams.
Block and Diagram browser	Expandable tree that lists the VisSim blocks, and target-specific and Digital Motor Control blocks (under Embedded) that you can drag-and-drop into the work area. The lower portion of the browser displays the currently opened diagram.
Status bar	Displays information about the current state of your block diagram, including the total number of blocks in the diagram, and the simulation range, step size, and integration algorithm. If a simulation is running, the current simulation time is also displayed.

VisSim Example

The VisSim install includes many examples you can compile and run. Fig 1 below shows the top level of the “Chip Temp on F28069” example. You can access this diagram from the VisSim menu: *Embedded > Examples > Piccolo > Chip Temp on F28069*.

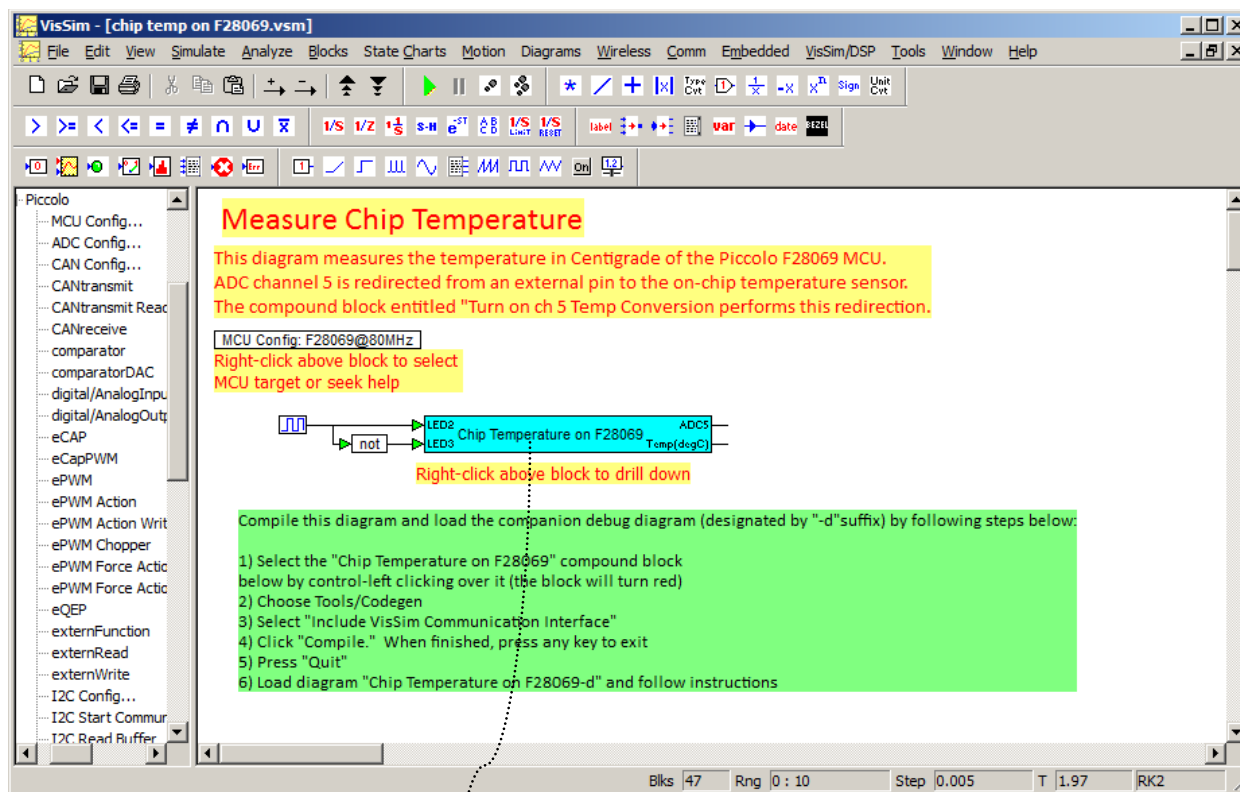

Figure 1: VisSim Example included in download

A right click on the “Chip Temperature on F28069” compound block above navigates to its contents shown in Fig 2 below. Compound blocks provide encapsulation giving an organizational hierarchy to your design.

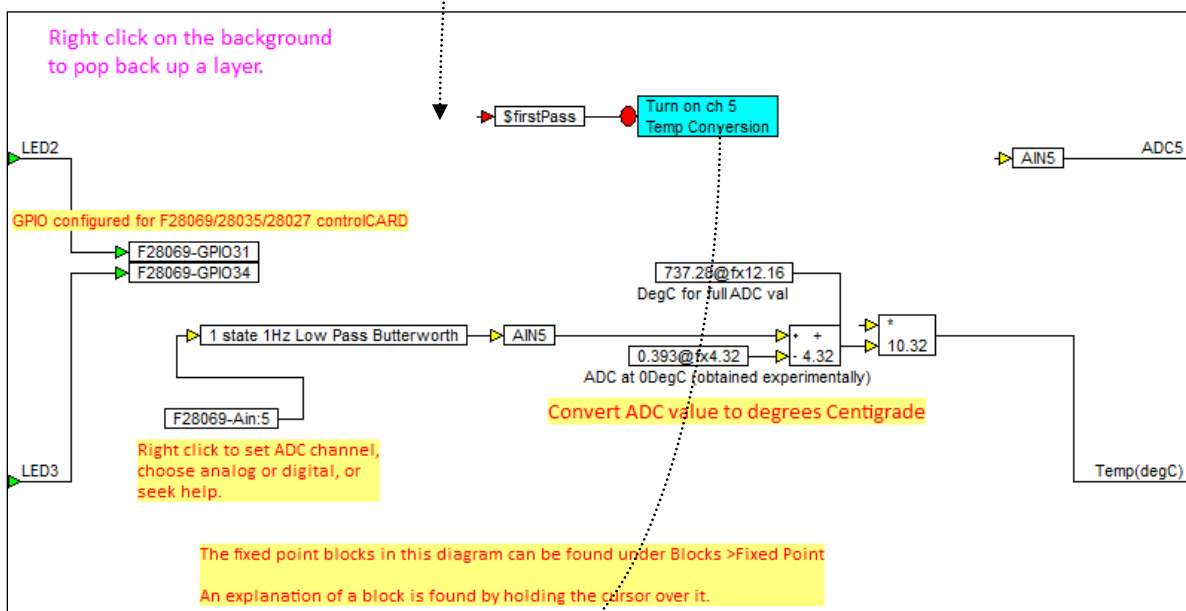

Figure 2: Contents of "Chip Temperature on F28069" Block after right click on containing block from Fig 1.

Fig 2 shows the VisSim code to read ADC channel 5 and apply an offset and gain to convert the reading to degrees Centigrade. It also executes some code "Turn on ch 5: Temp Conversion" to switch ADC 5 from an external pin to the internal temperature sensor. Note this block is triggered by the VisSim built-in variable "\$firstPass", that means this block and its contents are executed once at boot time.

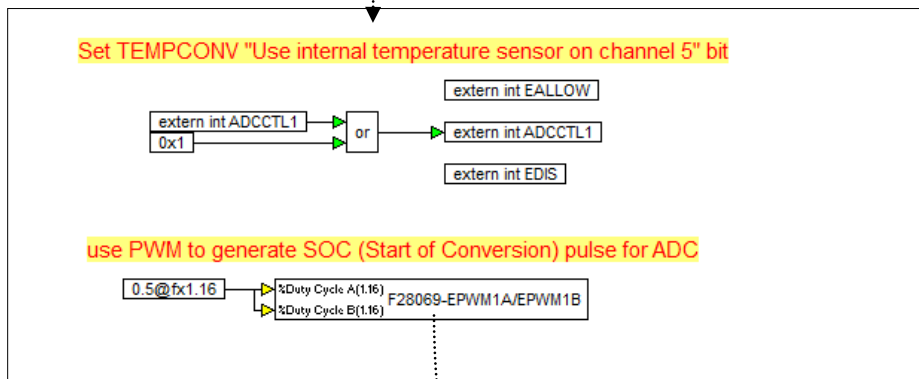

Figure 3: Contents of "Turn on ch 5 Temp Conversion" block shown after right click on containing block from Fig 2.

Fig 3 shows the contents of "Turn on ch 5: Temp Conversion". This VisSim code enables the internal temp sensor on ADC A5. Extern Read and Write blocks are used to write directly to hardware registers. To enforce the order of execution, VisSim executes parallel flows in top down order.

This code also enables a PWM block to send Start of Conversion pulses to ADC A5.

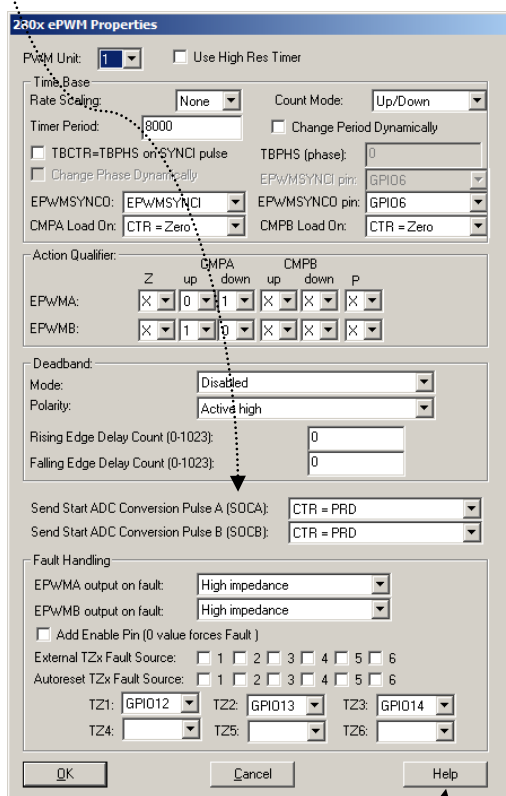

Figure 4: Piccolo ePWM configure dialog. Obtained via right mouse on EPWM block in Fig 3.

All VisSim blocks have help information that can be accessed via the "Help" button.

Compiling the source diagram

To compile the source diagram, first select the compound block that contains the code to run on the target. To select a block, Ctrl+Left click on it. Then select menu item: *Tools > Code Gen...*, to get the Code Generation dialog. Check "Include Vissim Communication Interface" so that we can debug the target executable, and click "Compile..." to generate C code and compile it with Code Composer.

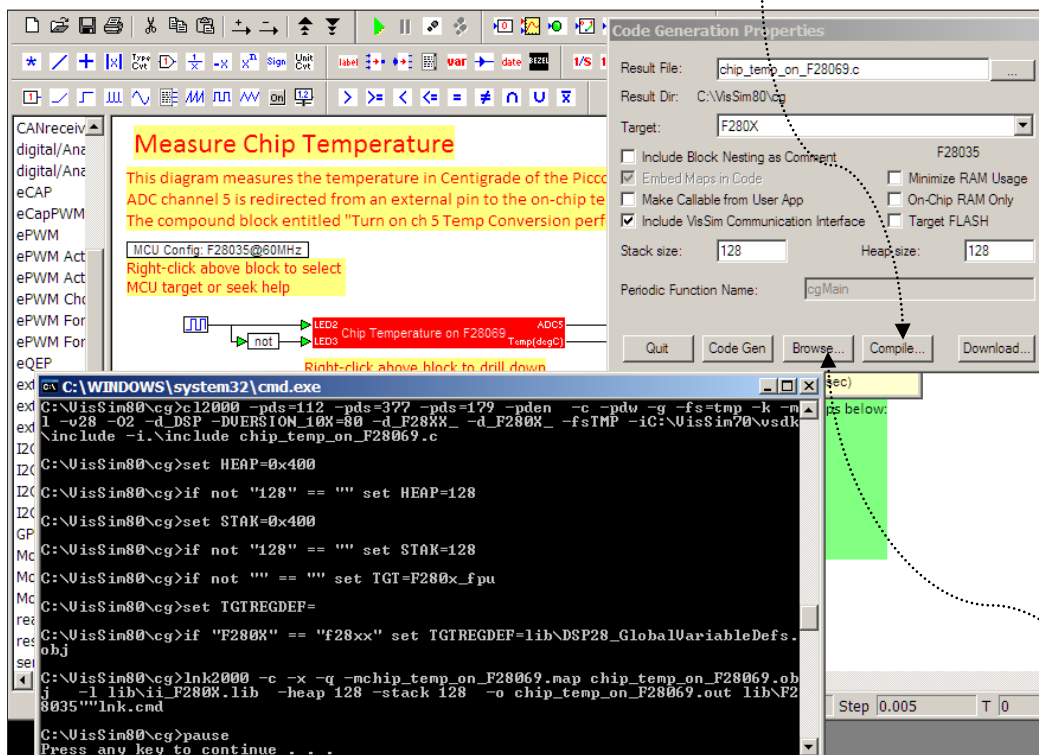

Figure 5: Generating Code for the Chip Temp on F28069 diagram.

A DOS window will appear showing the output of the Code Composer compile and link of your diagram. You can check to make sure the compile (cl2000) and link (link2000) were error free, and then press any key to continue. If you click the Browse button, you can examine the generated C-code.

After compiling the VisSim source diagram, you download it and debug it using the companion debug diagram shown below. It is also included in the VisSim trial and can be accessed from the VisSim menu: *Embedded > Examples > Piccolo > Chip Temp on F28069-d*.

Downloading and Debugging

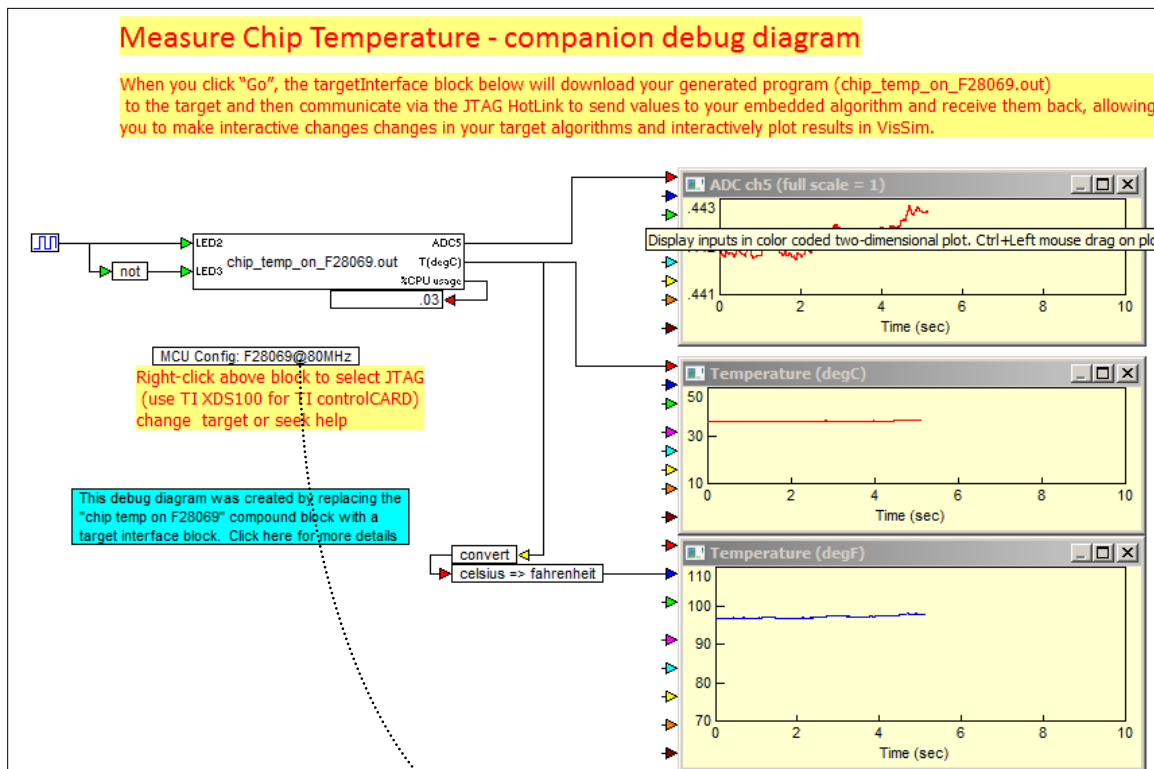

Figure 6 Chip Temp on F28069-d companion debug diagram

After opening the debug diagram, right click on the MCU Config block to make sure that the proper JTAG linkage is selected. The controlCARD and controSTICK use XDS100.

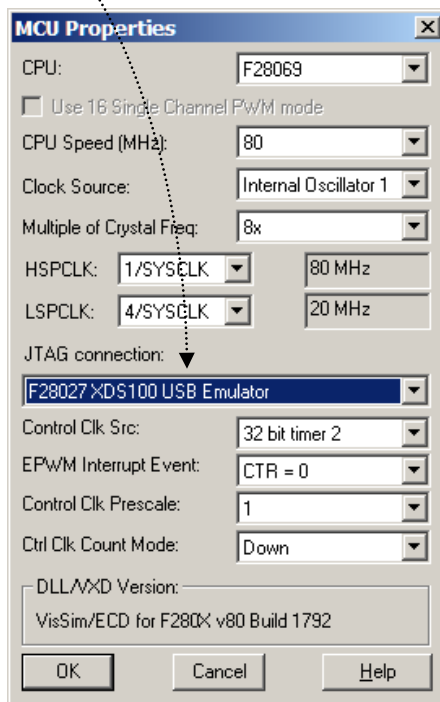

Figure 7: Target Configuration Dialog. Select CPU, System Clock, Main Timer Interrupt and JTAG linkage

Setting Diagram parameters

You set the main run rate of the diagram for both simulation and generated code for the target in the Simulation Properties Dialog under *Time Step*. For simulation purposes you can also set the integration algorithm and duration of the simulation.

To specify Diagram parameters

Choose **System > Simulation Properties**.

The Diagram System Properties dialog box is displayed.

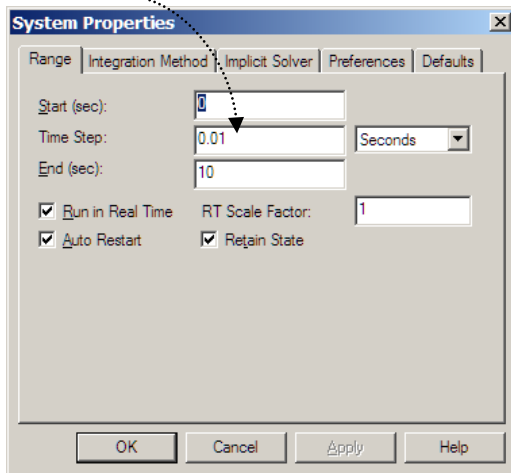



Figure 8: System Properties Dialog

The dialog in Fig. 8 is from the *Chip Temp on F28069-d* debug diagram. Notice the options used in the debug diagram:

- *Start* of 0 and *End* of 10 will give a 10 second interval on plots.
- *Time Step* of .005 gives a 200 Hz update rate to data and plots.
- *Run in Real Time* will cause the diagram to execute in real-time. This will cause VisSim to run in sync with the target.
- *Auto Restart* will cause VisSim to run continuously until stopped by the user.
- *Retain State* causes VisSim to refrain from reinitializing blocks on restart and prevents reload of the .out file

Running the diagram and viewing the results

Click the “go”  button to download and run the .out file you created when you compiled the source diagram. After it starts running on the target, VisSim will provide interactive inputs (in this case a 1 Hz square wave to the GPIO's to blink on-board LED's on TI control STICK or controlCARD) and interactive plots of on-chip outputs (in this case raw ADC A5 reading and adjusted temperature in Centigrade).

The diagram runs until the stop  button is clicked. The plot blocks display interactively as shown in Fig 6.

Pure Simulation

VisSim also supports pure simulation. Below we show the second integral of a step function. This was made by bringing a step block, 2 integration blocks and a plot block into the work area from either the browser to the left or from the blocks menu above and wiring them together.

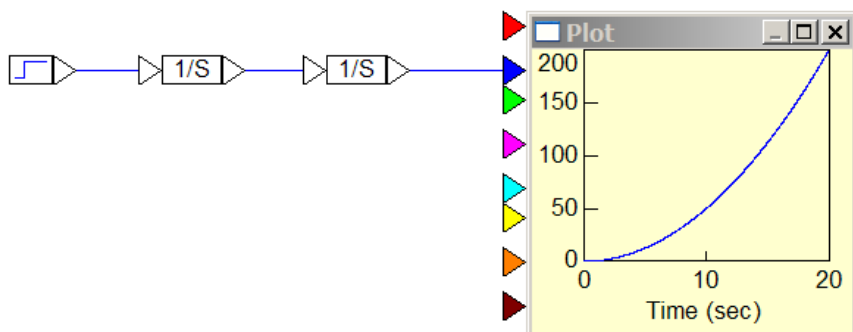

The diagram above represents the 2nd integral of a constant step set to 1. We expect the result to be $X^2/2$

If you click the  button, you will see the parabolic results above, as expected.

Where to go from here...

To help you get started with VisSim/ECD, we recommend you check out the following:

- Sample diagrams
- On-line movies

Sample diagrams

Your VisSim/ECD software comes with numerous pre-built examples of embedded system design targeting the Piccolo F28069. We recommend you open, explore, and simulate the diagrams.

Note A number of the diagrams have a companion diagram with a “-d” extension. These diagrams use the targetInterface block, which downloads the generated code to the Piccolo. Directions for loading the -d diagrams are contained in the corresponding block diagram.

To access these diagrams

- Click on **Embedded > Examples > Piccolo**.

Diagram Name	Description
ADCtestF28069	Reads voltages on five analog-to-digital channels.
blinkF28069	Sends a 1Hz square wave to the LED on the Piccolo.
chip temp on F28069	Measures the temperature in centigrade of the Piccolo.
fft28069	Puts internally-generated sin or ADC0 into circular buffer, then periodically calculates FFT and phase/magnitude in background task. FFT spectrum is displayed interactively in digital scope.
sinF28069	Generates a fixed-point sin wave and a fixed-point ramp on the Piccolo.
softblinkF28069	Generates a “soft” PWM signal by sampling at 10kHz and comparing a 0.5Hz triangle to a 100Hz ramp and sending the compare output to a GPIO connected to an LED.

VisSim movies

Designed by Visual Solutions application engineers, the VisSim movies guide you through creation, simulation, debug, and optimization of block diagrams that cover a broad range of embedded applications.

To access the movies

- Click on http://www.vissim.com/support/vissim_instructional_movies.html.

Movie	See How To
Introduction to VisSim/ECD	Build a fixed-point controller and generate code for the target.
Fixed Point Modeling and Code Generation	Use fixed-point blocks to simplify fixed-point algorithm development.
F280x ADC, Filter Design, and Waveform Monitoring	Configure the F28xx ADC unit and create a fixed-point IIR filter.
Digital Power Design with F280x	Create and tune 10 simultaneous buck converters.
Using the F280x Enhanced PWM	Configure the ePWM unit and dynamically change/display PWM waveforms by controlling phase, duty cycle, time-based synchronization, action qualifier, and chopper.

About Visual Solutions

Since 1989 Visual Solutions has been a pioneer in the development of visual software for model-based development of control systems. Our mission is to provide easy-to-use, powerful and affordable modeling, simulation and embedded system design software. For additional information, visit www.vissim.com.

Visual Solutions is proud to be a Texas Instruments partner.

